

## Gateway DMX – KNX TP

Code: EK-BK1-TP



Data sheet STEKKBK1TP\_EN  
V1.02 – 11 2015

KNX device with gateway function (protocol conversion) between a serial RS485 network (Master function) with DMX protocol and a KNX TP network over a twisted pair communication cable. Ideal application in integration of DMX devices over a RS485 serial network in a KNX-based automation system for homes and buildings.

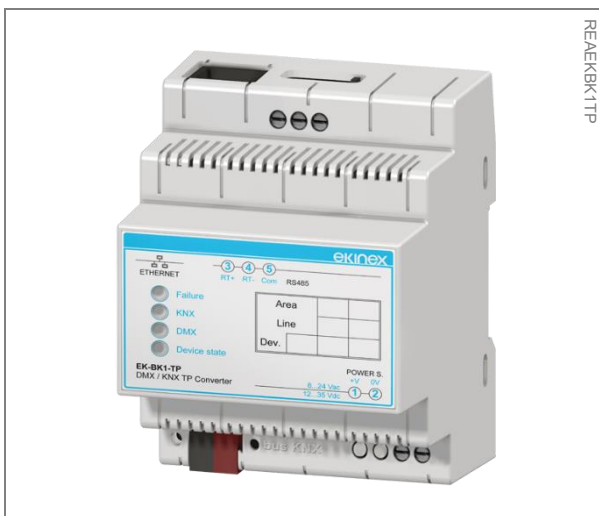

### Description

The DMX ekinex® EK-BK1-TP gateway is a KNX modular unit for panel mounting. It allows you to exchange information with one or more slave devices over a RS485 differential serial network through DMX protocol. The ekinex gateway acts as DMX master. The information exchanged over the DMX network is updated over the KNX network by means of a twisted pair (TP) communication cable.

The device manages a one-way data stream: up to 12 bytes of KNX data are defined, each one associated with a device over the DMX network. The gateway converts the data coming from the KNX master and writes its value on the corresponding DMX device.

Configuration is performed through a PC application software which communicates through the integrated Ethernet port.

The application software CGEKBK1TP is available for download at [www.ekinex.com](http://www.ekinex.com).

### Main features

#### DMX side

- RS485 serial communication port, electrically isolated from power supply, 120 Ω termination resistance insertable by a 1-way microswitch
- DMX master communication
- Baud rate: 250 kbaud
- Device addressing from 0 to 512
- 1-byte register writing on max 512 DMX devices

#### KNX side

- KNX TP (Twisted Pair) communication port set to 9600 baud, electrically isolated from power supply

#### Ethernet port

- Ethernet communication port (IEEE 802.3), RJ45 connector, minimum cable category: 5E.

### Technical data

- Power supply: 8...24 Vac or 12...35 Vdc. Power Absorption at 24 Vdc: 3,5 VA.
- Installation on 35 mm DIN rail (according to EN 60529)
- Plastic case
- Protection degree IP20 (according to EN 60529)
- Safety class II
- Weight 145 g
- Modular device 4 UM (1 UM = 18 mm)
- Dimensions 72 x 90 x 60 mm (WxHxD)

### Environmental conditions

- Operating temperature: - 40 ... + 85°C
- Stock temperature: - 25 ... + 55°C
- Transportation temperature: - 25 ... + 70°C
- Relative humidity: 93% non-condensing

### Display and command elements

The device is equipped with a pushbutton and a KNX programming LED, with a status LED and terminal blocks for KNX and RS485 network connection. A port for RJ45 connector for device configuration via Ethernet as well as two 1-way microswitches are also present.

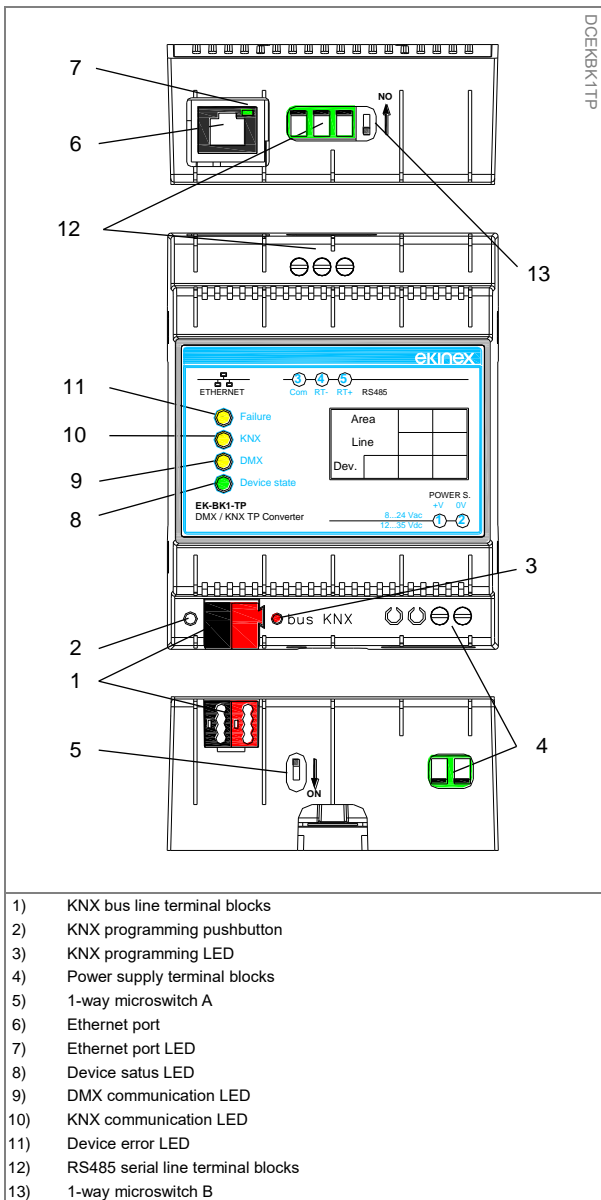

### Command elements

- Pushbutton that switches between normal mode and KNX physical address programming.

### 1-way microswitches

- A - OFF: normal mode active. ON: Boot mode active
- B - OFF: open. ON: RS485 line termination inserted (120 Ω termination resistance in parallel between RT+ and RT-)

### Display elements

The device can run according to two operating modes: Normal mode (configuration loaded, Modbus and KNX communication running) and Boot mode (no configuration or configuration still loading).

- Green LED (8) – Device status. Normal mode: Slow blinking (~1 Hz). Boot mode: ON= device on; OFF= device off.
- Yellow LED (9) – DMX communication. Normal mode: blinks when a frame is received on the RS485 port. Boot mode: if fast blinking: no configuration, if very slow blinking (~0,5 Hz): loading configuration.

- Yellow LED (10) – KNX communication. Normal mode: blinks when a frame is received. Boot mode: if fast blinking: no configuration, if very slow blinking (~0,5 Hz): loading configuration.
- Yellow LED (11) – Device error. Normal mode: ON= at least one DMX request did not get a correct answer; OFF= no error. Boot mode: if fast blinking: no configuration, if very slow blinking (~0,5 Hz): loading configuration.
- Green LED (7) – Ethernet port. Normal mode: ON= Ethernet connector plugged; OFF= Ethernet connector unplugged. Boot mode: ON= Ethernet connector plugged; OFF= Ethernet connector unplugged.
- Red LED (3) – KNX programming. Normal mode: ON= physical address programming mode on; OFF= physical address programming mode off. Boot mode: if fast blinking: no configuration, if very slow blinking (~0,5 Hz): loading configuration.

### Installation

The device has IP20 protection degree and is therefore suitable for dry indoor environments. The case is suitable for mounting on a DIN rail (according to EN 60715) inside electrical distribution cabinets. The proper installation involves the bus terminal blocks to be in the lower side. For installation proceed as follows:

- with the aid of a tool bring the locking device in completely lowered position (1);
- place the device on the upper edge of the DIN rail (2);
- rotate the device towards the DIN rail (3);
- push the locking device up until it stops (4).

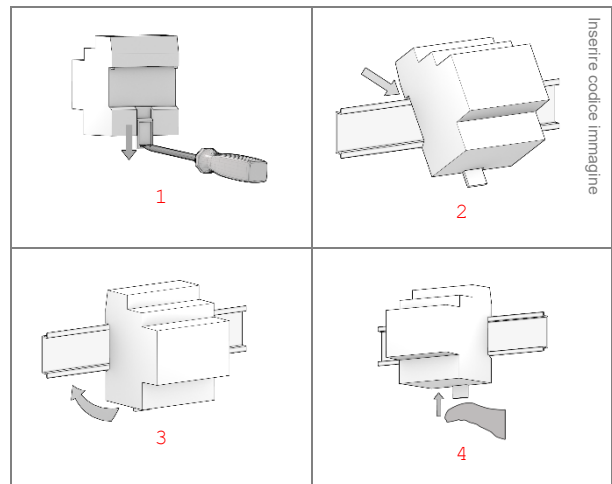

To unmount the device, make sure to unplug the network connection and the bus terminal from its housing. Use a screwdriver to slide down the lock and remove the device from the rail.



**Note.** It is recommended to install the device so to always guarantee full frontal accessibility, in order to properly display the status LEDs.

### Power supply connection

The device supports a very wide range of supply

voltages, both DC and AC.

	Vmin	Vmax
Vac	8	24
Vdc	12	35

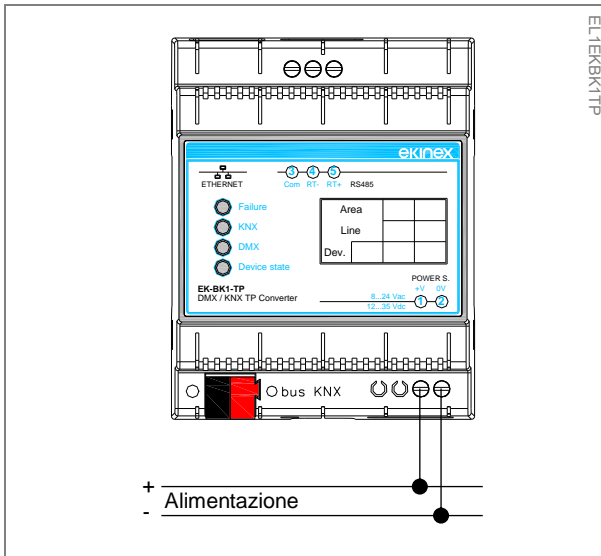

**Important!** In case of DC power supply, DO NOT reverse the terminal blocks polarity!

## KNX connection

Connection to KNX bus is made via the supplied KNX terminal block. The terminal block must be inserted into the slot located on the lower front side of the device.

### KNX terminal block features

- Conductors' spring clamping
- 4 conductors' location for each polarity
- Suitable for KNX bus cables with single-wire conductors (diameter between 0.6 and 0.8 mm)
- Recommended wire stripping: 5 mm
- Color code: red = bus conductor + (positive), black = bus conductor - (negative)

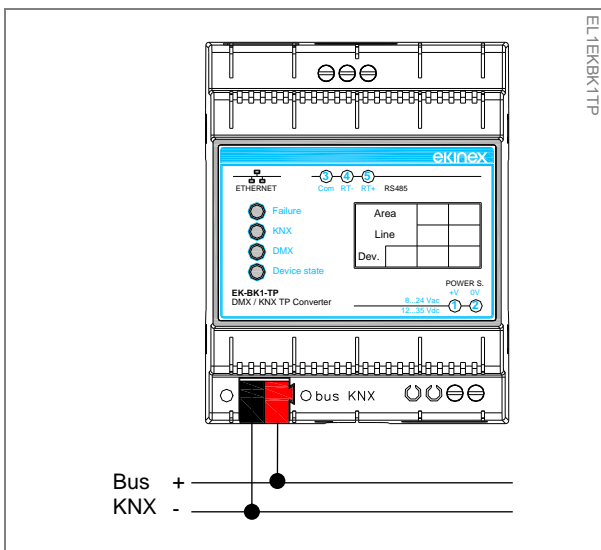

## RS485 DMX connection

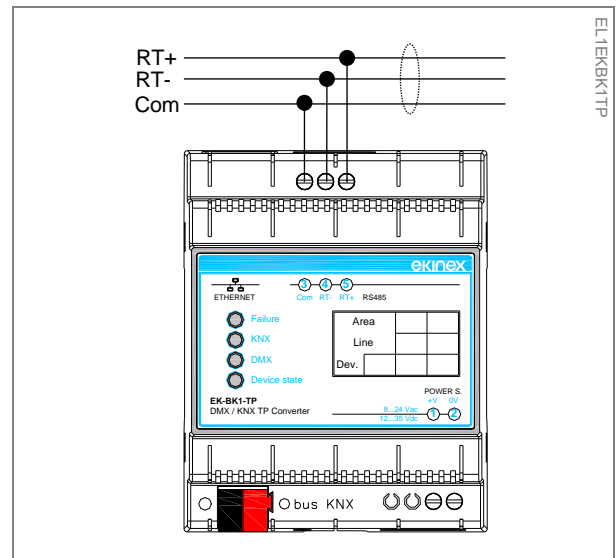

In order to terminate the RS485 network and balance the line impedance, you must enter the terminating resistor (120 Ω), by setting ON the 1-way microswitch B.

The maximum extension of the RS485 network is 1200 m.

Below are some recommended cable codes for wiring the RS485 line:

- Belden code 8132. 2x 28AWG twisted pairs of conductors + foil shielding + shielding mesh;
- Belden code 82842. 2x 24AWG twisted pairs of conductors + foil shielding + shielding mesh;
- Tasker code C521. 1x 24AWG twisted wire pair + foil shielding + shielding mesh;
- Tasker code C522. 2x 24AWG twisted pairs of conductors + foil shielding + shielding mesh.

## Configuration and commissioning

Configuration and commissioning of the ekinex® gateway must be performed using the application program CGEKBK1TP, available for download at [www.ekinex.com](http://www.ekinex.com).

### System requirements for configuration software

- Desktop or laptop PC with Ethernet IEEE 802.3 port.
- 32/64 bit operating system, Microsoft Windows® XP, 7, 8.0, 8.1 e 10.



**Note.** .NET Framework 4.0 system library installation is required.

The ekinex® configuration software CGEKBK1TP allows you to perform the following operations:

- Selection of physical address of the device over the KNX TP network;
- Selection of Ethernet parameters (for configuration download only);
- KNX network: communication objects definition and relative group addresses to be acquired; communication objects definition and relative group addresses to be sent over the KNX network;
- DMX network: default values definition;
- Firmware and/or configuration update.



**Note.** Configuration and commissioning of the ekinex® gateway require specialized skills about KNX networks and knowledge of the specific ETS automation project. In order to acquire such skills, it is essential to attend trainings and workshops organized at KNX-certified training centers. For further information: [www.knx.it](http://www.knx.it).

## Dimensions [mm]

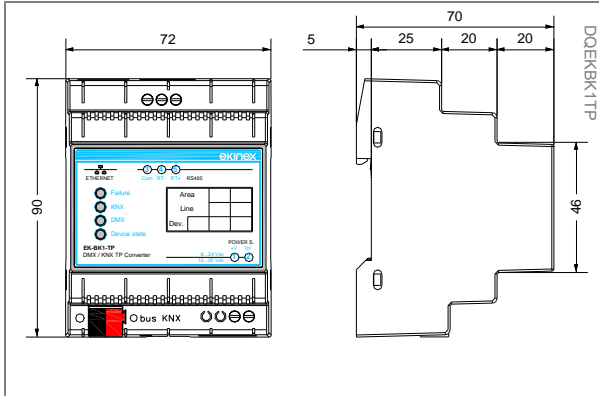

## Certifications



The product complies with the Low Voltage Directive (2006/95 / EC) and Electromagnetic Compatibility Directive (2004/108 / EC)



The product is compliant with 2002/95 / EC Directive about usage restriction of certain hazardous substances in electrical and electronic equipment (commonly referred to as the Restriction of Hazardous Substances or RoHS).

## Maintenance

The device is maintenance free. To clean it, use a dry cloth. Using solvents or other aggressive substances is strictly forbidden.

## Disposal



The product described in this data sheet, at the end of its useful life, is classified as waste from electronic equipment, according to the European Directive 2002/96 / EC (WEEE), implemented in Italy by Legislative

Decree no. 151 of 25 July 2005, and can not be disposed as solid municipal waste.



**Importante!** Improper disposal of the product may cause serious damage to the environment and human health. For proper disposal refer to collection and treatment informations provided by local authorities.

## Document

This data sheet refers to the release A1.0 of the ekinex® device code EK-BK1-TP and is available for download on the site [www.ekinex.com](http://www.ekinex.com) PDF (Portable Data Format).

Filename	Release	Update
STEKBK1TP_EN.pdf	A1.0	06 / 2021

## Warning

- Installation, electrical connection, configuration and commissioning of the device can only be carried out by qualified personnel.
- Opening the housing of the device causes the immediate end of the warranty period.
- ekinex® KNX defective devices must be returned to the manufacturer at the following address: EKINEX S.p.A. Via Novara 37, I-28010 Vaprio d'Agogna (NO) Italy.

## Other information

- This application manual is aimed at installers, system integrators and planners
- For further information on the product, please contact the ekinex® technical support at the e-mail address: [support@ekinex.com](mailto:support@ekinex.com) or visit the website [www.ekinex.com](http://www.ekinex.com)
- KNX® and ETS® are registered trademarks of KNX Association cvba, Brussels

© EKINEX S.p.A The company reserves the right to make changes to this documentation without notice.